

detail of glazing
see vertical cross-section

System Schröders
Innovation Tür und Tor
Gerhard-Welter-Straße 7; D-41812 Erkelenz

double leaf steel fire door
E240/EW60
"System Schröders ES-2"
horizontal cross-section

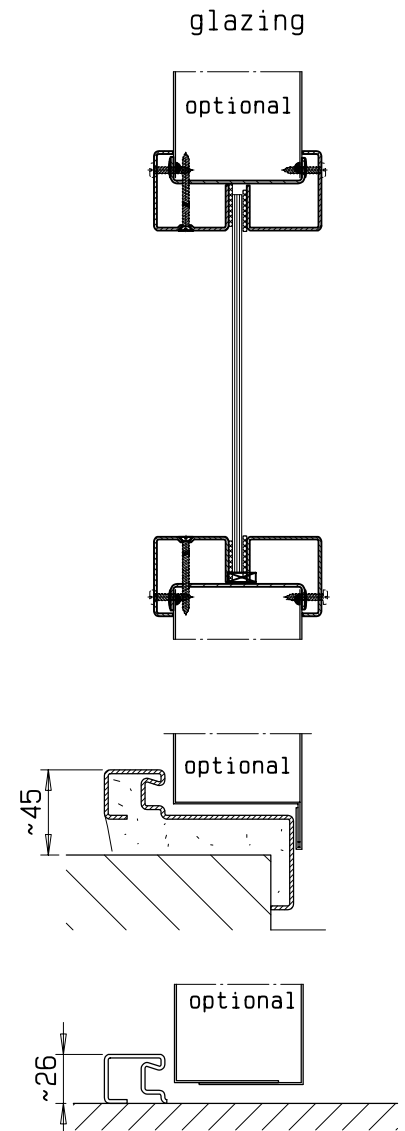
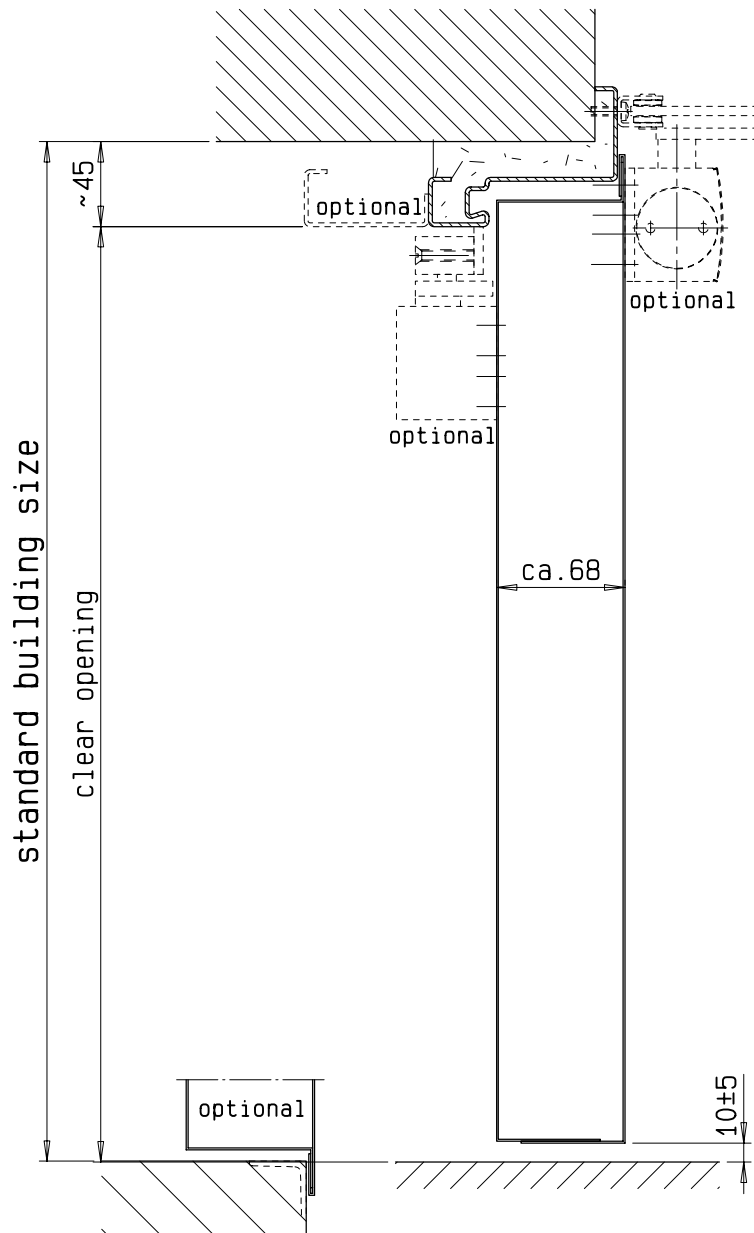

fitting details respectively frames, look at horizontal cross-section

System Schröders
Innovation Tür und Tor

Gerhard-Welter-Straße 7; D-41812 Erkelenz

double leaf steel fire door
E240/EW60
"System Schröders ES-2"
vertical cross-section